

QRG

FLUKE

True  
RMS

# T6-1000 PRO Electrical Tester with FieldSense Technology

⚠️ 请参阅安全须知。

访问 [www.fluke.com](http://www.fluke.com) 注册您的产品并获取更多信息，或者下载本快速参考指南的其他语言版本。一般安全须知内容详见本产品随附的印刷版《安全须知》。在适用的情况下，还会列出一些更具体的安全须知。有关完整技术指标，请访问 [www.fluke.com](http://www.fluke.com)。

17.8 mm (0.7 in)

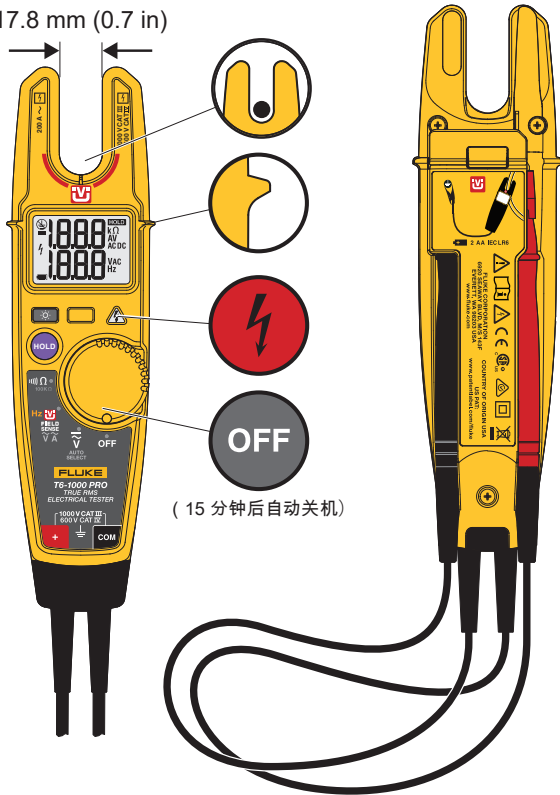

## 符号

|  |                   |
|--|-------------------|
|  | 危险电压 30 V。        |
|  | 用叉口和接地探针或鳄鱼夹进行测试。 |
|  | 电池已充满电。           |
|  | 电池电量低。请换电池。       |
|  | 背光                |
|  | 用探针进行测试。          |
|  | 无接地连接。            |



## 电线的正确放置

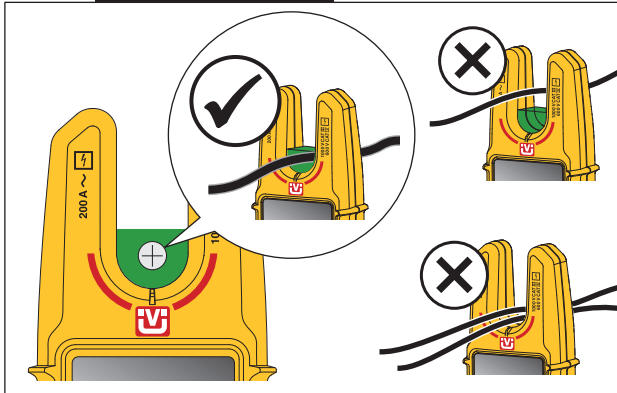

## 护手板

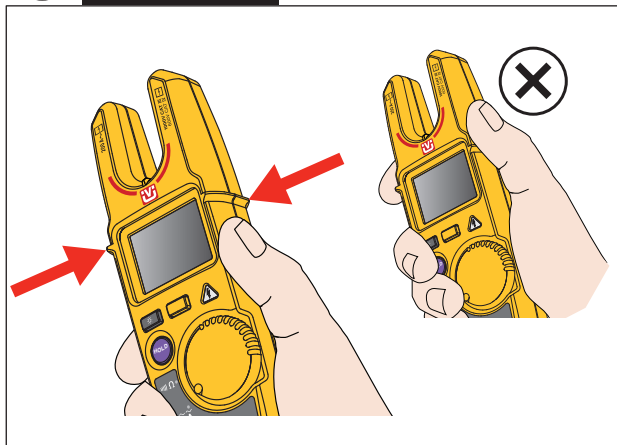

1

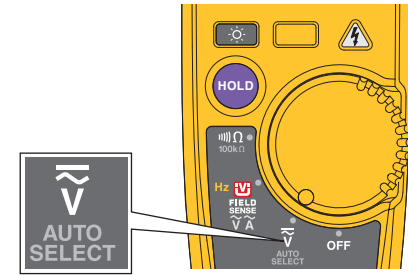

2A

$\tilde{V}$  (AC)

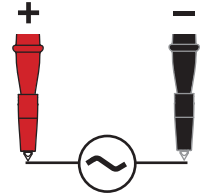

2B

$\bar{V}$  (DC)

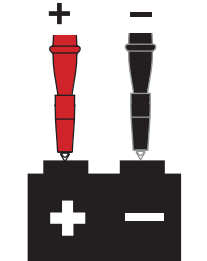

HOLD

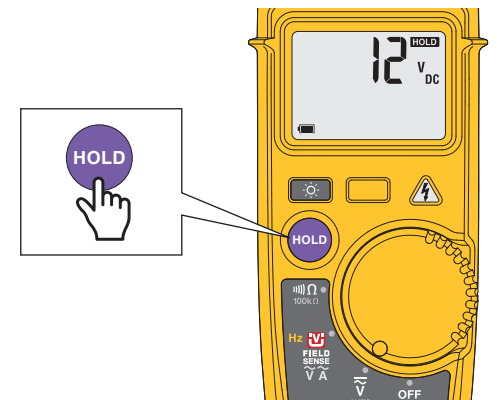

~ / V̄ / Hz /

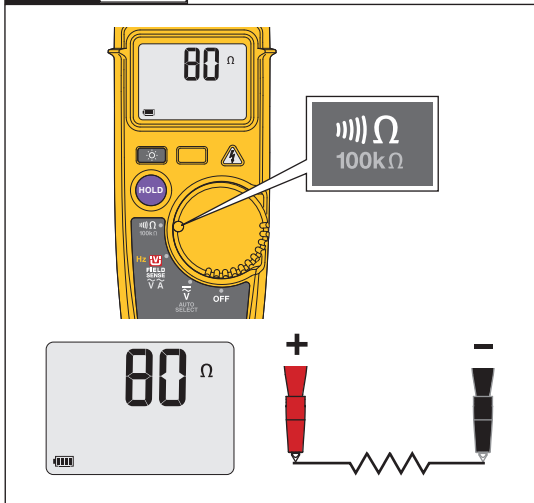
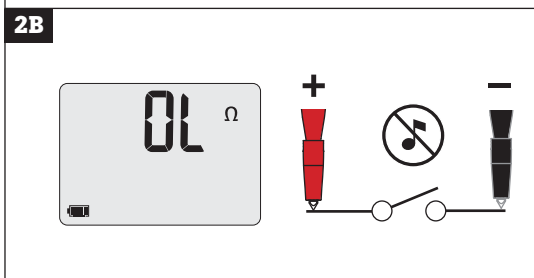
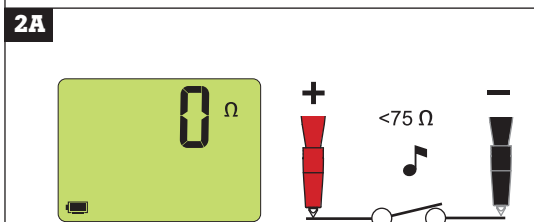
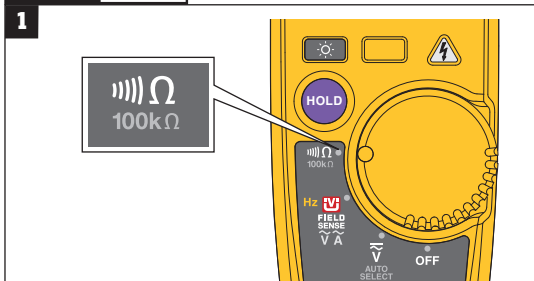
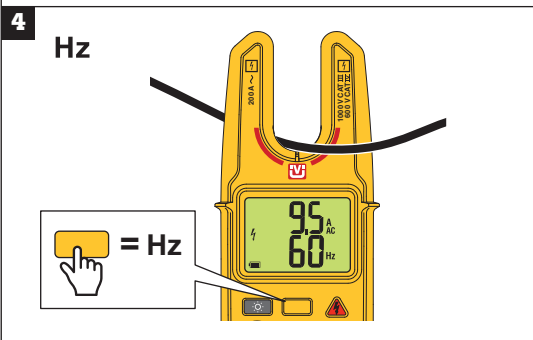
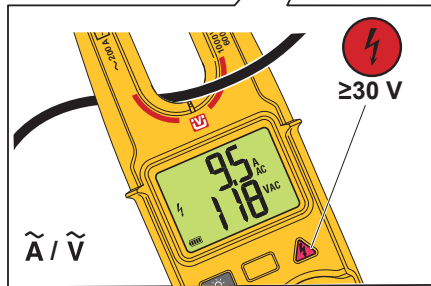
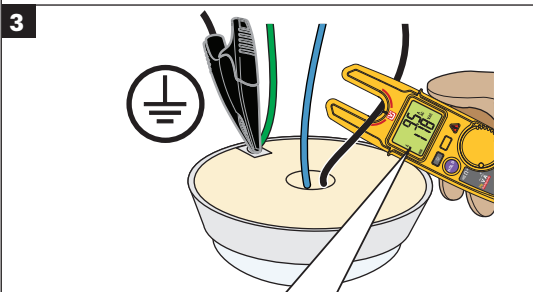
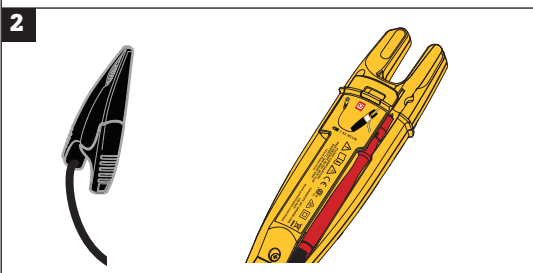
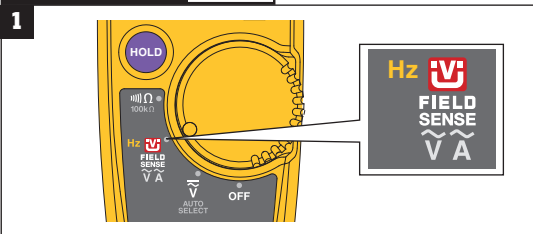

## 导线更换

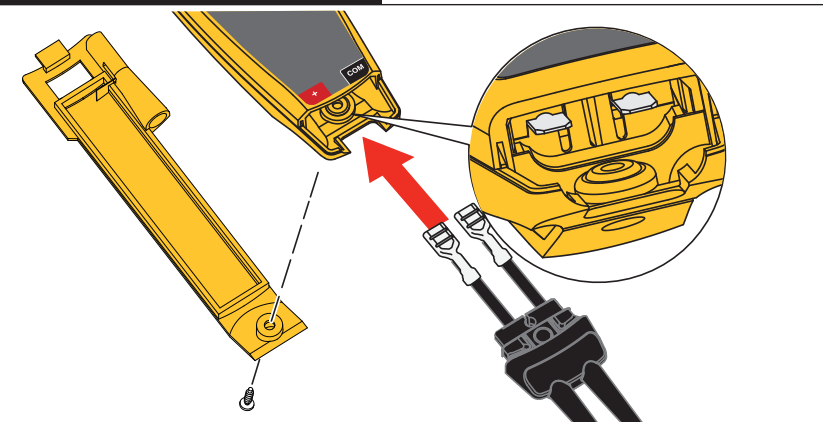

## 替换零件

|                                      |            |
|--------------------------------------|------------|
| 测试导线组件 (T5-RLS)。只能使用 Fluke 双重绝缘导线替换。 | PN 4462973 |
| TP1 单探头, 平头尖端, 红色                    | PN 648128  |
| TP1 单探头, 平头尖端, 黑色                    | PN 648102  |
| TP38 单探头, 圆头尖端, 红色                   | PN 1276841 |
| TP38 单探头, 圆头尖端, 黑色                   | PN 1276852 |
| 电池盖                                  | PN 5132103 |
| 电池盖螺丝                                | PN 1618578 |
| AC285 鳄鱼夹                            | PN 1610159 |
| H-T6 皮带套                             | PN 4910585 |

